



# Protocols for Laboratory Verification of Performance of the BIOFIRE® SPOTFIRE® Respiratory/Sore Throat (R/ST) Panel

## Laboratory Protocols for Use with ZeptoMetrix NATtrol™ Control Materials

### Purpose

---

The Clinical Laboratory Improvement Amendments (CLIA), passed in 1988, establishes quality standards for all laboratory testing to ensure the accuracy and reliability of patient test results, regardless of where the test is performed. The CLIA regulations include a requirement for verifying the performance specifications of unmodified, moderate complexity tests cleared or approved by the FDA.

This document provides examples of procedures to assist your laboratory in developing a protocol for the verification of the BIOFIRE® SPOTFIRE® Respiratory/Sore Throat (R/ST) Panel performance on the BIOFIRE® SPOTFIRE® System. Multiple verification schemes compatible with the SPOTFIRE R/ST Panel have been designed using non-clinical specimens. The methods described provide positive and negative tests for each organism detected by the SPOTFIRE R/ST Panel Respiratory and Sore Throat menus and may be easily modified or expanded to meet specific criteria. Day-to-day variation is evaluated by testing each sample on two separate days. To evaluate operator-to-operator variation, multiple laboratory technicians may test the same sample. In addition, testing patient samples for verification or to evaluate matrix effects on the performance of the SPOTFIRE R/ST Panel should be done under the guidance of the Laboratory Director, but is not described here.

As per the CLIA regulation, the Laboratory Director is ultimately responsible for ensuring that verification procedures meet the appropriate standards for CLIA and applicable laboratory accrediting agencies.

### Intended Use

---

The BIOFIRE® SPOTFIRE® Respiratory/Sore Throat (R/ST) Panel is a multiplexed polymerase chain reaction (PCR) test intended for use with the BIOFIRE® SPOTFIRE® System for the simultaneous, qualitative detection and identification of multiple respiratory viral and bacterial nucleic acids in nasopharyngeal swab (NPS) specimens obtained from **individuals with signs and symptoms of respiratory tract infection, including COVID-19; (Respiratory menu)** or in throat swab (TS) specimens from **individuals with signs and symptoms of pharyngitis (Sore Throat menu)**.





The following organism types and subtypes are identified and differentiated using the SPOTFIRE R/ST Panel:

**Table 1: SPOTFIRE R/ST Panel Menu**

Respiratory Menu	Sore Throat Menu
<b>Viruses</b>	<b>Viruses</b>
Adenovirus	Adenovirus
Coronavirus SARS-CoV-2	Coronavirus (seasonal)
Coronavirus (seasonal)	Human metapneumovirus
Human metapneumovirus	Human rhinovirus/enterovirus
Human rhinovirus/enterovirus	Influenza A virus
Influenza A virus	Influenza A virus/ H1-2009
Influenza A virus/ H1-2009	Influenza A virus/ H3
Influenza A virus/ H3	Influenza B virus
Influenza B virus	Parainfluenza virus
Parainfluenza virus	Respiratory syncytial virus
Respiratory syncytial virus	
<b>Bacteria</b>	<b>Bacteria</b>
<i>Bordetella paraptussis</i>	<i>Chlamydia pneumoniae</i>
<i>Bordetella pertussis</i>	<i>Mycoplasma pneumoniae</i>
<i>Chlamydia pneumoniae</i>	<i>Streptococcus dysgalactiae</i> (Group C/G Strep)
<i>Mycoplasma pneumoniae</i>	<i>Streptococcus pyogenes</i> (Group A Strep)

The complete intended use statement and additional information about the use of the SPOTFIRE R/ST Panel can be found in the *BIOFIRE® SPOTFIRE® Respiratory/Sore Throat (R/ST) Panel Instructions for Use*.

## Performance Verification: Overview

Three different examples of performance verification procedures are described: (1) a Respiratory Protocol for the verification of the SPOTFIRE R/ST Panel performance using the Respiratory Menu; (2) a Sore Throat Protocol for verification of the SPOTFIRE R/ST Panel performance using the Sore Throat Menu; and (3) a Combined Respiratory and Sore Throat Protocol for verification of both the Respiratory and Sore Throat Panel Menus. Each protocol can be used with a different media or expanded to test multiple media to evaluate matrix effects. Refer to the *BIOFIRE® SPOTFIRE® Respiratory/Sore Throat (R/ST) Panel Instructions for Use* for a complete list of acceptable media types. These protocols are examples of procedures to assist your laboratory in developing a protocol for the verification of SPOTFIRE R/ST Panel performance on the SPOTFIRE System.



**Note:** Transport media may contain non-viable organisms and/or nucleic acids at levels that can be detected by the SPOTFIRE R/ST Panel and may lead to false positive results. Transport media may be screened using the SPOTFIRE R/ST Panel prior to starting the verification procedure. The optimal transport media will be negative for all analytes tested on the SPOTFIRE R/ST Panel.

The procedures have been designed to take advantage of the multiplex nature of the SPOTFIRE R/ST Panel. Verification testing efficiency is maximized by evaluating multiple target organisms in a single test run. The procedures described will generate multiple positive and negative detections for each of the SPOTFIRE R/ST Panel



assays. The procedures were developed using the NATrol™ Respiratory/Sore Throat Verification Panel (NATRST-BIO) available from ZeptoMetrix, Buffalo, NY.

A SPOTFIRE System is composed of one to four BIOFIRE® SPOTFIRE® Modules connected to a BIOFIRE® SPOTFIRE® Control Station running BIOFIRE® SPOTFIRE® Software. If the laboratory director chooses not to perform the entire verification protocol on each individual module of the SPOTFIRE System, it is advised that test replicates are evenly distributed among the modules. Examples of performance verification workflows using 1 to 4 modules is provided in Figures 1 through 4.

Clinical/patient samples may be used in place of, or in addition to the verification schemes described here to assess clinical sensitivity/specificity and sample matrix effects as part of the performance verification of the SPOTFIRE R/ST Panel.



**Note:** The laboratory should only perform the verification study with analytes that will be reported using the SPOTFIRE R/ST Panel and with sample types and media that will be used in their laboratory setting.

**Table 2.** Overview of Verification Protocols

Verification Protocol	Organisms per Pool	Number of Sample Pools	Replicates per Sample Pool	Pouches Required <sup>a</sup>	Expected Positive Results <sup>s</sup>	Expected Negative Results	Approximate Days of Testing <sup>c</sup>
<b>Example 1: Respiratory</b>	4, 6, or 7	4	4	16	≥4 per organism	≤12 per organism	2
<b>Example 2: Sore Throat</b>	4, 5, 6, or 7	4	4	16	≥4 per organism	≤12 per organism	2
<b>Example 3: Combined Respiratory and Sore Throat</b>	6 or 7	4	8	32	≥8 per organism	≤24 per organism	4

<sup>a</sup> Pouches required does not include pouches that may be needed for screening transport media.

<sup>b</sup> The expected number of positives and negatives per organism is dependent upon the number strains of a particular organism used to complete the verification. The proposed verification procedure recommends multiple strains of adenovirus, coronavirus (seasonal) and parainfluenza virus; therefore, the number of expected positive and negative detections for adenovirus, coronavirus (seasonal) and parainfluenza virus will vary.

<sup>c</sup> Two days is shown to meet day-to day testing requirements; the number of days can be expanded or decreased, as needed.

## Performance Verification: Materials

The following materials may be used to perform the verification procedure:





**Table 3.** Recommended materials for the verification protocols

Material	Part Number
BIOFIRE® SPOTFIRE® Respiratory/Sore Throat (R/ST) Panel Test Kit (30 tests)	BioFire Diagnostics, LLC: 423485
BIOFIRE® SPOTFIRE® Respiratory/Sore Throat (R/ST) Panel Instructions for Use	BioFire Diagnostics, LLC: BFR0000-2787
BIOFIRE® SPOTFIRE® Respiratory/Sore Throat (R/ST) Panel Quick Guide	BioFire Diagnostics, LLC: BFR0002-5494
BIOFIRE® SPOTFIRE® System Operator Manual	BioFire Diagnostics, LLC: BFR0001-1641
Control Organisms <sup>a</sup>	ZeptoMetrix NATrol™ Respiratory/Sore Throat (R/ST) Verification Panel: NATRST-BIO
Transport Media <sup>b</sup> (e.g., BD™ 3 mL Universal Viral Transport Media) for Nasopharyngeal swab (NPS)/ Respiratory Menu or Remel MicroTest™ M4RT® Multi-Microbe Media <sup>b</sup> for NPS/ Respiratory menu	BD 220220 or Copan 3C047N; ThermoFisher R12700
Amies Medium <sup>b</sup> for Throat Swab (TS)/ Sore Throat Menu	Copan Eswab™ 480C
5 mL Sample Tubes	Various manufacturers
Disposable Transfer Pipets, graduated	VWR, 414004-024 (or equivalent)

<sup>a</sup> Any appropriate source of organism may be used for verification of any or all of the assays in the SPOTFIRE R/ST Panel. However, when alternate organism sources are used (i.e. not the ZeptoMetrix control material), the sample volumes or pooling schemes suggested in the examples below may need to be adjusted.

<sup>b</sup> The media above was validated for use with the SPOTFIRE R/ST Panel, however, other commercial liquid media may be appropriate. Refer to the Materials Required but Not Provided and the Interference section of the BIOFIRE® SPOTFIRE® Respiratory/Sore Throat (R/ST) Panel Instructions for Use for more details.

## Performance Verification: Respiratory Protocol

The Respiratory Protocol evaluates the SPOTFIRE R/ST Panel performance when control material (ZeptoMetrix NATRST-BIO) is pooled and combined with an equal volume of transport media or synthetic matrix/negative (provided in the control panel) and tested with the Respiratory Menu. The proposed organism pooling scheme (Table 4) should be followed to obtain the expected number of positive and negative results for each assay in a time and resource-efficient manner.

Verification sample tests should be run by following on-screen instructions for patient sample testing. Refer to the *BIOFIRE® SPOTFIRE® Respiratory/Sore Throat (R/ST) Panel Instructions for Use* or the *BIOFIRE® SPOTFIRE® Respiratory/Sore Throat (R/ST) Panel Quick Guide* for detailed instructions.



- Note:** Dilution of ZeptoMetrix control organisms beyond levels proposed in these guidelines may lead to inconsistent results and is not recommended.
- Note:** Transport media may contain non-viable organisms and/or nucleic acids at levels that can be detected by the SPOTFIRE R/ST Panel and may lead to false positive results. Transport media may be screened using the SPOTFIRE R/ST Panel (Respiratory Menu) prior to starting the verification procedure. The optimal transport media will be negative for all analytes tested on the SPOTFIRE R/ST Panel Respiratory Menu.

Figures 1 and 2 (below) illustrate workflow schemes for testing 4 replicates per pool for 4 different pools over multiple days. This produces a total of 16 verification sample test runs and provides at least 4 positive results and as many as 12 negative results per assay. Some organisms, such as adenovirus, are represented multiple times. This is done to ensure all adenovirus assays are represented in the verification protocol. The number of samples tested per day should be determined by the individual laboratory. This testing scheme can be modified to run fewer samples per day based on the number of modules in the SPOTFIRE System. The pooling scheme provides sufficient volume for testing more replicates if desired.

Pooled samples may be stored overnight (or up to 14 days) at refrigeration temperature (2–8°C) for subsequent testing to evaluate day-to-day variation. To evaluate operator-to-operator variation, multiple laboratory technicians may perform testing.

**Table 4.** Proposed Organism Pooling Scheme for the Verification of the SPOTFIRE R/ST Panel Respiratory Menu

Verification Panel Organisms (Respiratory Menu)	Approximate Organism Volume	Approximate Volume Transport Media or Negative	Approximate Pool Volume
<b>Pool 1- Viruses</b>			
Adenovirus Type 3	0.3 mL	1.8 mL	3.6 mL
SARS-CoV-2 (USA-WA1/2020)	0.3 mL		
Influenza A H1N1pdm (A/NY/02/092-subtype H1-2009)	0.3 mL		
Influenza B (B/Florida/02/06)	0.3 mL		
Parainfluenza Type 4	0.3 mL		
Rhinovirus 1A	0.3 mL		
<b>Pool 2- Viruses</b>			
Adenovirus Type 1	0.3 mL	2.1 mL	4.2 mL
Coronavirus 229E	0.3 mL		
Coronavirus HKU-1 (recombinant)	0.3 mL		
Metapneumovirus 8 (Peru6-2003)	0.3 mL		
Influenza AH3 (A/Brisbane/10/07-subtype H3)	0.3 mL		
Parainfluenza Type 1	0.3 mL		
Parainfluenza Type 2	0.3 mL		
<b>Pool 3- Viruses</b>			
Adenovirus Type 31	0.3 mL	1.8 mL	3.6 mL
Coronavirus OC43	0.3 mL		
Coronavirus NL63	0.3 mL		
Influenza AH1 (A/New Caledonia/20/99- no subtype)	0.3 mL		
Parainfluenza Type 3	0.3 mL		
Respiratory Syncytial Virus A (RSV A)	0.3 mL		
<b>Pool 4- Bacteria</b>			





<i>Bordetella parapertussis</i> (A747)	0.3 mL	1.2 mL	2.4 mL
<i>Bordetella pertussis</i> (A639)	0.3 mL		
<i>Chlamydia pneumoniae</i> (IOL-207)	0.3 mL		
<i>Mycoplasma pneumoniae</i> (M129)	0.3 mL		

## Example of Protocol for Respiratory Verification

The estimated total time to complete this verification example is 2 days for a SPOTFIRE System configured with 1 to 4 modules. Testing over multiple days provides day-to-day variation data; testing with multiple operators provides operator-to-operator variation data; testing multiple replicates of pooled verification material verifies precision of the test system.

 **Note:** It is important to prepare only the number of sample pools that will be tested within 14 days of preparation. The number of samples prepared may be modified based on the laboratory's work schedule and number of modules connected within a SPOTFIRE System.



### Day 1- Respiratory Protocol

1. Organize materials needed (Table 3); refer to Table 4 for the pooling scheme. Negativity of transport media may be confirmed by screening on the SPOTFIRE R/ST Panel (Respiratory Menu) prior to starting the verification procedure. Negative vials included in the control panel contain 1.8 mL of synthetic matrix; the control panel contains sufficient volume to complete the protocol described. More than one vial of negative may be needed for preparing some pools (i.e., Pool 2).
2. Prepare one sample pool (i.e., Pool 1) using the ZeptoMetrix NATRST-BIO control materials. Organism vials should be mixed vigorously for 5 seconds prior to preparing each pool.
  - a. Transfer 0.3 mL of material from the ZeptoMetrix organism vial into a 5 mL tube.
  - b. Repeat with the second (and subsequent) organisms to combine the appropriate organisms for each pool into a single tube. The combined volume of organisms for each pool will be between 1.2 and 2.1 mL, depending upon the pool.
  - c. Add transport media or synthetic matrix/negative (as described in Table 4) to the tube containing the organism pool (step b). The volume of transport media/ negative should be the same as the organism pool volume, for example: for Pools 1 and 3, 1.8 mL of transport media/negative is added to 1.8 mL of pooled organism. The final volume of Pools 1 and 3 will be approximately 3.6 mL.

 **Note:** If the laboratory verification study will include multiple types of transport media, see the section *Expanding or Modifying the Protocol* below.

3. Repeat Step 2 for the remaining sample pools (i.e., Pools 2, 3, and 4) to be prepared on Day 1.
4. Test 2 replicates from a single sample pool (Figure 1: Pool 1 replicates A and B) using the Respiratory Menu. Ensure the pooled sample is well mixed prior to removing a sample for testing. Replicate samples A and B should be tested in a single day by different operators to evaluate operator-to-operator variance. Refer to Figure 2 for suggested workflows depending upon the module configuration in the verification study.



- 
**Note:** For each sample, follow instructions in the *BIOFIRE® SPOTFIRE® Respiratory/Sore Throat (R/ST) Panel Instructions for Use* or the *BIOFIRE® SPOTFIRE® Respiratory/Sore Throat (R/ST) Panel Quick Guide* for pouch preparation, pouch hydration, sample loading, and sample testing. Verification sample tests should be run by following on-screen instructions for patient sample pouch testing.
  
- 5. Repeat Step 4 for the remaining sample replicates to be tested that day (Figure 1: replicates A and B for Pools 2, 3 and 4).
  
- 6. Refrigerate samples (2–8°C) for up to 14 days for the evaluation of day-to-day variation.
  
- 
**Note:** The proposed organism pooling scheme, described in Table 4, provides sufficient material for running samples as described in Figure 1. The volume is sufficient for testing more samples if desired.

## Day 2 - Respiratory Protocol

To evaluate day-to-day variation, test additional replicates from the pools prepared on Day 1 by repeating Steps 4 and 5 above (Figure 1: test replicates C and D from Pools 1-4).

- 
**Note:** A Verification Record for the SPOTFIRE R/ST Respiratory Menu protocol is provided and may serve as a template for recording your results.

**Figure 1.** Verification Protocol Workflow for Testing One Menu (Respiratory or Sore Throat) over Two Days

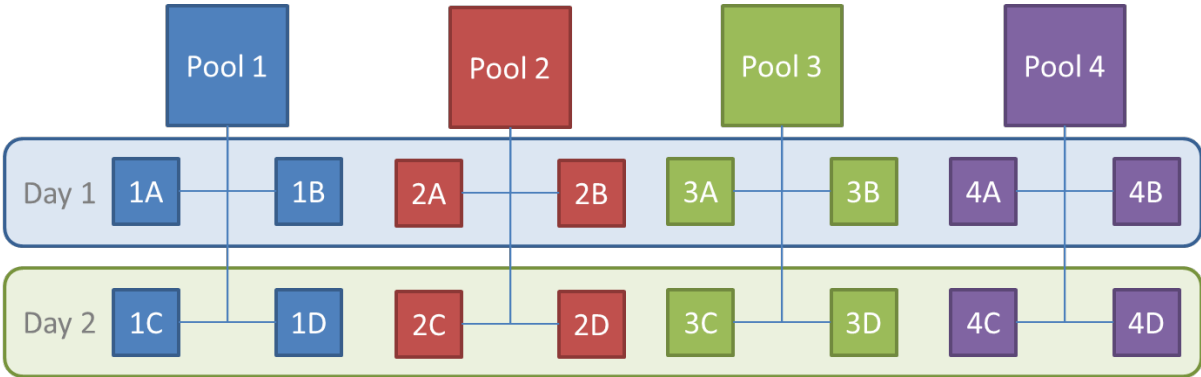



**Figure 2.** Examples of the Verification Workflow for Testing One Menu (Respiratory or Sore Throat) over two days with different SPOTFIRE System Module configurations

Verification with One Module				
Testing Day	Module 1			
Day 1	Pool 1A/ Operator 1	Pool 2A/ Operator 1	Pool 3A / Operator 1	Pool 4A / Operator 1
	Pool 1B/ Operator 2	Pool 2B/ Operator 2	Pool 3B / Operator 2	Pool 4B / Operator 2
Day 2	Pool 1C/ Operator 1	Pool 2C/ Operator 1	Pool 3C / Operator 1	Pool 4C / Operator 1
	Pool 1D/ Operator 2	Pool 2D/ Operator 2	Pool 3D / Operator 2	Pool 4D / Operator 2

Verification with Two Modules				
Testing Day	Module 1		Module 2	
Day 1	Pool 1A/ Operator 1	Pool 2A/ Operator 1	Pool 1B/ Operator 2	Pool 2B/ Operator 2
	Pool 3A / Operator 1	Pool 4A / Operator 1	Pool 3B / Operator 2	Pool 4B / Operator 2
Day 2	Pool 1D/ Operator 2	Pool 2D/ Operator 2	Pool 1C/ Operator 1	Pool 2C/ Operator 1
	Pool 3D / Operator 2	Pool 4D / Operator 2	Pool 3C / Operator 1	Pool 4C / Operator 1

Verification with Three Modules						
Testing Day	Module 1		Module 2		Module 3	
Day 1	Pool 1A/ Operator 1	Pool 2B/ Operator 2	Pool 2A/ Operator 1	Pool 3B / Operator 2	Pool 1B/ Operator 2	Pool 3A / Operator 1
			Pool 4B / Operator 2		Pool 4A / Operator 1	
Day 2	Pool 1D/ Operator 2	Pool 3C / Operator 1	Pool 1C/ Operator 1	Pool 2D/ Operator 2	Pool 3D / Operator 2	Pool 2C/ Operator 1
	Pool 4C / Operator 1				Pool 4D / Operator 2	

Verification with Four Modules				
Testing Day	Module 1	Module 2	Module 3	Module 4
Day 1	Pool 1A/ Operator 1	Pool 1B/ Operator 2	Pool 2A/ Operator 1	Pool 2B/ Operator 2
	Pool 3B / Operator 2	Pool 3A / Operator 1	Pool 4B / Operator 2	Pool 4A / Operator 1
Day 2	Pool 2D/ Operator 2	Pool 2C/ Operator 1	Pool 1D/ Operator 2	Pool 1C/ Operator 1
	Pool 4C / Operator 1	Pool 4D / Operator 2	Pool 3C / Operator 1	Pool 3D / Operator 2









## Performance Verification: Sore Throat Protocol

The Sore Throat Protocol evaluates the SPOTFIRE R/ST Panel performance when control material (ZeptoMetrix NATRST-BIO) is pooled and combined with an equal volume of transport media, such as Amies, or negative/synthetic matrix (provided in the control panel) and tested with the Sore Throat Menu. The proposed organism pooling scheme (Table 5) should be followed to obtain the expected number of positive and negative results for each assay in a time and resource-efficient manner.

Verification sample tests should be run by following on-screen instructions for patient sample testing. Refer to the *BIOFIRE® SPOTFIRE® Respiratory/Sore Throat (R/ST) Panel Instructions for Use* or the *BIOFIRE® SPOTFIRE® Respiratory/Sore Throat (R/ST) Panel Quick Guide* for detailed instructions.

-  **Note:** Dilution of ZeptoMetrix control organisms beyond levels proposed in these guidelines may lead to inconsistent results and is not recommended.
-  **Note:** Transport media (including Amies) may contain non-viable organisms and/or nucleic acids at levels that can be detected by the SPOTFIRE R/ST Panel and may lead to false positive results. Transport media may be screened using the SPOTFIRE R/ST Panel (Sore Throat Menu) prior to starting the verification procedure. The optimal transport media will be negative for all analytes tested on the SPOTFIRE R/ST Panel Sore Throat Menu.

Figures 1 and 2 (above) illustrate workflow schemes for testing 4 replicates per pool for 4 different pools over multiple days. This produces a total of 16 verification sample test runs and provides at least 4 positive results and as many as 12 negative results per assay. Some organisms, such as adenovirus, are represented multiple times. This is done to ensure all adenovirus assays are represented in the verification protocol. The number of samples tested per day should be determined by the individual laboratory. This testing scheme can be modified to run fewer samples per day based on the number of modules in the SPOTFIRE System. The pooling scheme provides sufficient volume for testing more replicates if desired.

Pooled samples may be stored overnight (or up to 14 days) at refrigeration temperature (2–8°C) for subsequent testing to evaluate day-to-day variation. To evaluate operator-to-operator variation, multiple laboratory operators may perform testing.

**Table 5.** Proposed Organism Pooling Scheme for the Verification of the SPOTFIRE R/ST Panel Sore Throat Menu

Verification Panel Organisms (Sore Throat Menu)	Approximate Organism Volume	Approximate Volume Amies or Negative	Approximate Pool Volume
<b>Pool 1- Viruses</b>			
Adenovirus Type 3	0.3 mL	1.5 mL	3.0 mL
Influenza A H1N1pdm (A/NY/02/092-subtype H1-2009)	0.3 mL		
Influenza B (B/Florida/02/06)	0.3 mL		
Parainfluenza Type 4	0.3 mL		
Rhinovirus 1A	0.3 mL		





Pool 2- Viruses			
Adenovirus Type 1	0.3 mL	2.1 mL	4.2 mL
Coronavirus 229E	0.3 mL		
Coronavirus HKU-1 (recombinant)	0.3 mL		
Metapneumovirus 8 (Peru6-2003)	0.3 mL		
Influenza AH3 (A/Brisbane/10/07-subtype H3)	0.3 mL		
Parainfluenza Type 1	0.3 mL		
Parainfluenza Type 2	0.3 mL		
Pool 3- Viruses			
Adenovirus Type 31	0.3 mL	1.8 mL	3.6 mL
Coronavirus OC43	0.3 mL		
Coronavirus NL63	0.3 mL		
Influenza AH1 (A/New Caledonia/20/99- no subtype)	0.3 mL		
Parainfluenza Type 3	0.3 mL		
Respiratory Syncytial Virus A (RSV A)	0.3 mL		
Pool 4- Bacteria			
<i>Chlamydia pneumoniae</i> (IOL-207)	0.3 mL	1.2 mL	2.4 mL
<i>Mycoplasma pneumoniae</i> (M129)	0.3 mL		
<i>Streptococcus pyogenes</i>	0.3 mL		
<i>Streptococcus dysgalactiae</i>	0.3 mL		

## Example of Protocol for Sore Throat Verification

The estimated total time to complete this verification example is 2 days for a SPOTFIRE System configured with 1 to 4 modules. Testing over multiple days provides day-to-day variation data; testing with multiple operators provides operator-to-operator variation data; testing multiple replicates of pooled verification material verifies precision of the test system.



**Note:** It is important to prepare only the number of sample pools that will be tested within 14 days of preparation. The number of samples prepared may be modified based on the laboratory's work schedule and number of modules connected within a SPOTFIRE System.

### Day 1-Sore Throat Protocol

1. Organize materials needed (Table 3); refer to Table 5 for the pooling scheme. Negativity of transport media/Amies may be confirmed by screening on the SPOTFIRE R/ST Panel prior to starting the verification procedure. Negative vials included in the control panel contain 1.8 mL of synthetic matrix; the control panel contains sufficient volume to complete the protocol described. More than one vial of negative may be needed for preparing some pools (i.e., Pool 2).
2. Prepare one sample pool (i.e., Pool 1) using the ZeptoMetrix NATRST-BIO control materials. Organism vials should be mixed vigorously for 5 seconds prior to preparing each pool.
  - a. Transfer 0.3 mL of material from the ZeptoMetrix organism vial into a 5 mL tube.



- b. Repeat with the second (and subsequent) organisms to combine the appropriate organisms for each pool into a single tube. The combined volume of organisms for each pool will be between 1.2 to 2.1 mL, depending upon the pool.
- c. Add Amies or synthetic matrix/negative (as described in Table 5) to the tube containing the organism pool (step b). The volume of Amies/ negative should be the same as the organism pool volume, for example: for Pool 3, 1.8 mL of transport media/negative is added to 1.8 mL of pooled organism. The final volume of Pool 3 will be approximately 3.6 mL.

 **Note:** If the laboratory verification study will include multiple types of transport media, see the section *Expanding or Modifying the Protocol* below.

3. Repeat Step 2 for the remaining sample pools (i.e., Pools 2, 3, and 4) to be prepared on Day 1.
4. Test 2 replicates from a single sample pool (Figure 1: Pool 1 replicates A and B) using the Sore Throat Menu. Ensure the pooled sample is well mixed prior to removing a sample for testing. Replicate samples A and B should be tested in a single day by different operators to evaluate operator-to-operator variance. Refer to Figure 2 for suggested workflows depending upon the module configuration in the verification study.

 **Note:** For each sample, follow instructions in the *BIOFIRE® SPOTFIRE® Respiratory/Sore Throat (R/ST) Panel Instructions for Use* or the *BIOFIRE® SPOTFIRE® Respiratory/Sore Throat (R/ST) Panel Quick Guide* for pouch preparation, pouch hydration, sample loading, and sample testing. Verification sample tests should be run by following on-screen instructions for patient sample pouch testing.

5. Repeat Step 4 for the remaining sample replicates to be tested that day (Figure 1, replicates A and B for Pools 2, 3 and 4).
6. Refrigerate samples (2–8°C) for up to 14 days for the evaluation of day-to-day variation.

 **Note:** The proposed organism pooling scheme, described in Table 5, provides sufficient material for running samples as described in Figure 1. The volume is sufficient for testing more samples if desired.

## Day 2- Sore Throat Protocol

To evaluate day-to-day variation, test additional replicates from the pools prepared on Day 1 by repeating Steps 4 and 5 above (Figure 1: test replicates C and D from Pools 1-4).



 **Note:** A SPOTFIRE Sore Throat Menu Verification Record is provided and may serve as a template for recording your results.



## Performance Verification: Combined Protocol for Respiratory and Sore Throat

The combined verification protocol for Respiratory and Sore Throat evaluates the SPOTFIRE R/ST Panel performance when sample material (ZeptoMetrix NATRST-BIO) is pooled and combined with an equal volume of transport media, such as BD™ 3 mL Universal Viral Transport Media, or negative/synthetic matrix (provided in the control panel) and tested with the both the Respiratory and Sore Throat Menus. The proposed organism pooling scheme (Table 6) should be followed to obtain the expected number of positive and negative results for each assay in a time and resource-efficient manner.

Verification sample tests should be run by following on-screen instructions for patient sample testing. Refer to the *BIOFIRE® SPOTFIRE® Respiratory/Sore Throat (R/ST) Panel Instructions for Use* or the *BIOFIRE® SPOTFIRE® Respiratory/Sore Throat (R/ST) Panel Quick Guide* for detailed instructions.

-  **Note:** Dilution of ZeptoMetrix control organisms beyond levels proposed in these guidelines may lead to inconsistent results and is not recommended.
-  **Note:** Transport media may contain non-viable organisms and/or nucleic acids at levels that can be detected by the SPOTFIRE R/ST Panel and may lead to false positive results. Transport media may be screened using the SPOTFIRE R/ST Panel (Respiratory and Sore Throat Menus) prior to starting the verification procedure. The optimal transport media will be negative for all analytes tested on the SPOTFIRE R/ST Panel.

Figures 3 and 4 (below) illustrate workflow schemes for testing 8 replicates per pool for 4 different pools over multiple days. This produces a total of 32 verification sample test runs and provides at least 8 positive results and as many as 24 negative results per assay. Some organisms, such as adenovirus, are represented multiple times. This is done to ensure all adenovirus assays are represented in the verification protocol. The number of samples tested per day should be determined by the individual laboratory. This testing scheme can be modified to run fewer samples per day based on the number of modules in the SPOTFIRE System. The pooling scheme provides sufficient volume for testing more replicates if desired.

Pooled samples may be stored overnight (or up to 14 days) at refrigeration temperature (2–8°C) for subsequent testing to evaluate day-to-day variation. To evaluate operator-to-operator variation, multiple laboratory operators may perform testing.

**Table 6.** Proposed Organism Pooling Scheme for the Combined Verification of the SPOTFIRE R/ST Panel

Verification Panel Organisms (Respiratory and Sore Throat Menus, unless noted)	Approximate Organism Volume	Approximate Volume Amies, Transport Media or Negative	Approximate Pool Volume
<b>Pool 1 - Viruses</b>			
Adenovirus Type 3	0.3 mL	1.8 mL	3.6 mL
SARS-CoV-2 (USA-WA1/2020) (Respiratory Menu)	0.3 mL		
Influenza A H1N1pdm (A/NY/02/092-subtype H1-2009)	0.3 mL		
Influenza B (B/Florida/02/06)	0.3 mL		
Parainfluenza Type 4	0.3 mL		
Rhinovirus 1A	0.3 mL		







Pool 2- Viruses			
Adenovirus Type 1	0.3 mL	2.1 mL	4.2 mL
Coronavirus 229E	0.3 mL		
Coronavirus HKU-1 (recombinant)	0.3 mL		
Metapneumovirus 8	0.3 mL		
Influenza AH3 (A/Brisbane/10/07-subtype H3)	0.3 mL		
Parainfluenza Type 1	0.3 mL		
Parainfluenza Type 2	0.3 mL		
Pool 3- Viruses			
Adenovirus Type 31	0.3 mL	1.8 mL	3.6 mL
Coronavirus OC43	0.3 mL		
Coronavirus NL63	0.3 mL		
Influenza AH1 (A/New Caledonia/20/99- no subtype)	0.3 mL		
Parainfluenza Type 3	0.3 mL		
Respiratory Syncytial Virus A (RSV A)	0.3 mL		
Pool 4- Bacteria			
<i>Bordetella parapertussis</i> (A747) (Respiratory Menu)	0.3 mL	1.8 mL	3.6 mL
<i>Bordetella pertussis</i> (A639) (Respiratory Menu)	0.3 mL		
<i>Chlamydia pneumoniae</i> (IOL-207) (Respiratory and Sore Throat menu)	0.3 mL		
<i>Mycoplasma pneumoniae</i> (M129) (Respiratory and Sore Throat menu)	0.3 mL		
<i>Streptococcus pyogenes</i> (Sore Throat Menu)	0.3 mL		
<i>Streptococcus dysgalactiae</i> (Sore Throat Menu)	0.3 mL		

## Example of a Combined Protocol for Respiratory and Sore Throat Verification

This verification protocol example can be completed in 2 or more days depending on the number of modules in the SPOTFIRE System configuration and the laboratory's work schedule. Testing over multiple days provides day-to-day variation data; testing with multiple operators provides operator-to-operator variation data; testing multiple replicates of pooled verification material verifies precision of the test system.

- 
**Note:** It is important to prepare only the number of sample pools that will be tested within 14 days of preparation. The number of samples prepared may be modified based on the laboratory's work schedule and number of modules connected within a SPOTFIRE System.
- 
**Note:** If the laboratory verification study will include multiple types of transport media, see the section *Expanding or Modifying the Protocol* below.



## Day 1- Combined Respiratory and Sore Throat Protocol

1. Organize materials needed (Table 3); refer to Table 6 for the pooling scheme. Negativity of transport media may be confirmed by screening on the SPOTFIRE R/ST Panel prior to starting the verification procedure. Negative vials included in the control panel contain 1.8 mL of synthetic matrix; the control panel contains sufficient volume to complete the protocol described. More than one vial of negative may be needed for preparing some pools (i.e., Pool 2).
2. Prepare one sample pool (i.e., Pool 1) using the ZeptoMetrix NATRST-BIO control materials. Organism vials should be mixed vigorously for 5 seconds prior to preparing each pool.
  - a. Transfer 0.3 mL of material from the ZeptoMetrix organism vial into a 5 mL tube.
  - b. Repeat with the second (and subsequent) organisms to combine the appropriate organisms for each pool into a single tube. The combined volume of organisms for each pool will be between 1.8 to 2.1 mL, depending upon the pool.
  - c. Add transport media or synthetic matrix/negative (as described in Table 6) to the tube containing the organism pool (step b). The volume of transport media/ negative should be the same as the organism pool volume, for example: for Pools 1, 3, and 4, 1.8 mL of transport media/negative is added to 1.8 mL of pooled organism. The final volume of Pools 1, 3 and 4 will be approximately 3.6 mL.
3. Repeat Step 2 for the remaining sample pools (Figure 3: Pools 2, 3, and 4) to be prepared on Day 1.
4. Test 2 replicates from a single sample pool (Figure 3: Pool 1 replicates A and B) using the Respiratory Menu and 2 replicates (Figure 3: Pool 1 replicates C and D) using the Sore Throat Menu. Ensure the pooled sample is well mixed prior to removing a sample for testing. The replicate samples should be tested in a single day by different operators to evaluate operator-to-operator variance. Refer to Figure 4 for suggested workflows depending upon the module configuration in the verification study.



**Note:** For each sample, follow instructions in the *BIOFIRE® SPOTFIRE® Respiratory/Sore Throat (R/ST) Panel Instructions for Use* or the *BIOFIRE® SPOTFIRE® Respiratory/Sore Throat (R/ST) Panel Quick Guide* for pouch preparation, pouch hydration, sample loading, and sample testing. Verification sample tests should be run by following on-screen instructions for patient sample pouch testing.

5. Repeat Step 4 for the remaining sample replicates to be tested that day (Figure 3: replicates A and B for Pools 2, 3 and 4 using the Respiratory Menu and replicates C and D for Pools 2, 3 and 4 using the Sore Throat Menu).
6. Refrigerate samples (2–8°C) for up to 14 days for the evaluation of day-to-day variation.



**Note:** The proposed organism pooling scheme, described in Table 6, provides sufficient material for running samples as described in Figure 3. The volume is sufficient for testing more samples if desired.

## Day 2- Combined Respiratory and Sore Throat Protocol

To evaluate day-to-day variation, test additional replicates from the pools prepared on Day 1 by repeating Steps 4 and 5 above (Figure 3: test replicates E, F, G, and H from Pools 1-4).





**Note:** A SPOTFIRE Respiratory and Sore Throat Menu Verification Record is provided and may serve as a template for recording your results.

**Figure 3.** Verification Protocol Workflow for Testing Respiratory and Sore Throat Menus over Two Days

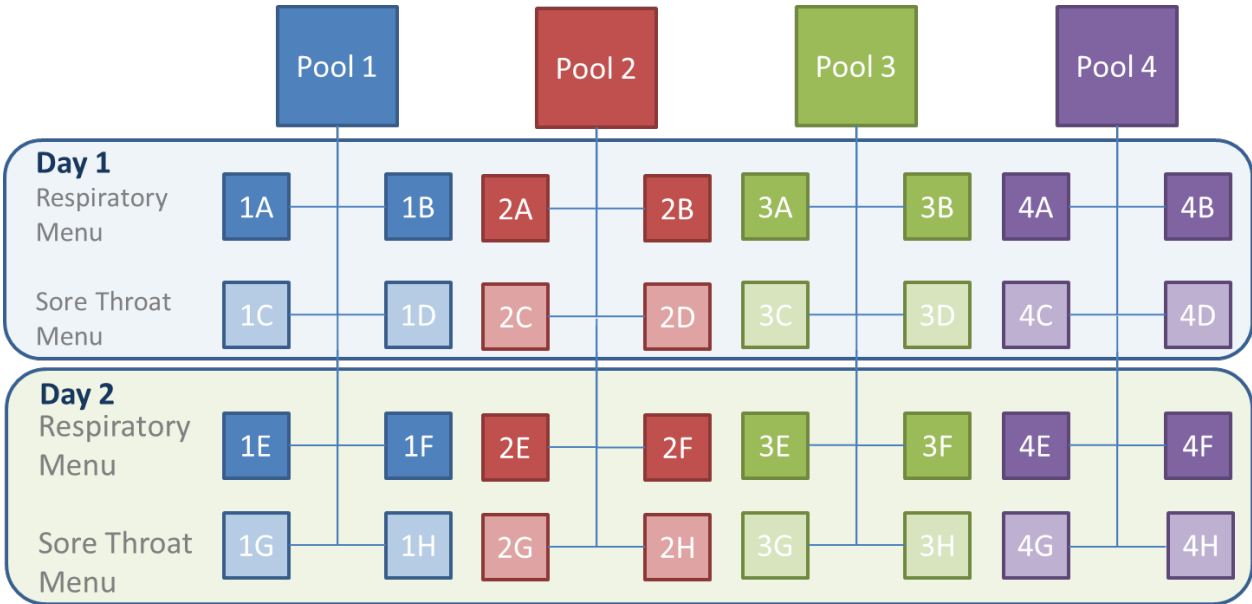



**Figure 4.** Examples of Verification Workflow testing over two days with different SPOTFIRE module configurations

Combined Protocol with 1 module		Module 1							
Day 1	Respiratory Menu	Pool 1A / Operator 1	Pool 1B / Operator 2	Pool 2A / Operator 1	Pool 2B / Operator 2	Pool 3A / Operator 1	Pool 3B / Operator 2	Pool 4A / Operator 1	Pool 4B / Operator 2
	Sore Throat Menu	Pool 1C / Operator 1	Pool 1D / Operator 2	Pool 2C / Operator 1	Pool 2D / Operator 2	Pool 3C / Operator 1	Pool 3D / Operator 2	Pool 4C / Operator 1	Pool 4D / Operator 2
Day 2	Respiratory Menu	Pool 1E / Operator 1	Pool 1F / Operator 2	Pool 2E / Operator 1	Pool 2F / Operator 2	Pool 3E / Operator 1	Pool 3F / Operator 2	Pool 4E / Operator 1	Pool 4F / Operator 2
	Sore Throat Menu	Pool 1G / Operator 1	Pool 1H / Operator 2	Pool 2G / Operator 1	Pool 2H / Operator 2	Pool 3G / Operator 1	Pool 3H / Operator 2	Pool 4G / Operator 1	Pool 4H / Operator 2

Combined Protocol with 2 modules		Module 1				Module 2			
Day 1	Respiratory Menu	Pool 1A / Operator 1	Pool 2A / Operator 1	Pool 3A / Operator 1	Pool 4A / Operator 1	Pool 1B / Operator 2	Pool 2B / Operator 2	Pool 3B / Operator 2	Pool 4B / Operator 2
	Sore Throat Menu	Pool 1C / Operator 1	Pool 2C / Operator 1	Pool 3C / Operator 1	Pool 4C / Operator 1	Pool 1D / Operator 2	Pool 2D / Operator 2	Pool 3D / Operator 2	Pool 4D / Operator 2
Day 2	Respiratory Menu	Pool 1F / Operator 2	Pool 2F / Operator 2	Pool 3F / Operator 2	Pool 4F / Operator 2	Pool 1E / Operator 1	Pool 2E / Operator 1	Pool 3E / Operator 1	Pool 4E / Operator 1
	Sore Throat Menu	Pool 1H / Operator 2	Pool 2H / Operator 2	Pool 3H / Operator 2	Pool 4H / Operator 2	Pool 1G / Operator 1	Pool 2G / Operator 1	Pool 3G / Operator 1	Pool 4G / Operator 1

Combined Verification with 3 modules		Module 1			Module 2			Module 3		
Day 1	Respiratory Menu	Pool 1A / Operator 1	Pool 2A / Operator 1	Pool 3A / Operator 1	Pool 1B / Operator 2	Pool 2B / Operator 2	Pool 4B / Operator 2	Pool 3B / Operator 2	Pool 4A / Operator 1	
	Sore Throat Menu	Pool 1C / Operator 1	Pool 2C / Operator 1	Pool 4C / Operator 1		Pool 3D / Operator 2	Pool 4D / Operator 2	Pool 1D / Operator 2	Pool 2D / Operator 2	Pool 3C / Operator 1
Day 2	Respiratory Menu	Pool 1F / Operator 2	Pool 2F / Operator 2	Pool 4F / Operator 2	Pool 1E / Operator 1	Pool 3E / Operator 1	Pool 4E / Operator 1	Pool 2E / Operator 1	Pool 3F / Operator 2	
	Sore Throat Menu		Pool 3H / Operator 2	Pool 4H / Operator 2	Pool 2G / Operator 1	Pool 1H / Operator 2	Pool 3G / Operator 1	Pool 1G / Operator 1	Pool 2H / Operator 2	Pool 4G / Operator 1

Combined Verification with 4 modules		Module 1		Module 2		Module 3		Module 4	
Day 1	Respiratory Menu	Pool 1A / Operator 1	Pool 3A / Operator 1	Pool 1B / Operator 2	Pool 3B / Operator 2	Pool 2A / Operator 1	Pool 4A / Operator 1	Pool 2B / Operator 2	Pool 4B / Operator 2
	Sore Throat Menu	Pool 1D / Operator 2	Pool 3D / Operator 2	Pool 1C / Operator 1	Pool 3C / Operator 1	Pool 2D / Operator 2	Pool 4D / Operator 2	Pool 2C / Operator 1	Pool 4C / Operator 1
Day 2	Respiratory Menu	Pool 2F / Operator 2	Pool 4F / Operator 2	Pool 2E / Operator 1	Pool 4E / Operator 1	Pool 1F / Operator 2	Pool 3F / Operator 2	Pool 1E / Operator 1	Pool 3E / Operator 1
	Sore Throat Menu	Pool 2G / Operator 1	Pool 3G / Operator 1	Pool 2H / Operator 2	Pool 3H / Operator 2	Pool 1G / Operator 1	Pool 4G / Operator 1	Pool 1H / Operator 2	Pool 4H / Operator 2







## Expanding or Modifying the Protocol

The protocols described above can be expanded by increasing the number of tests from each of the organism pools. Each organism pool contains sufficient volume for testing additional replicates. Some examples of expanding the verification study to include multiple media types are described below, but these should be done under the guidance of the Laboratory Director.

**Note:** The laboratory should perform the verification study with specimen types and media that will be used with the SPOTFIRE R/ST Panel in their laboratory setting.

- 1) The verification study may use multiple types of transport media in the pools, as needed. Each organism pool can be prepared using a different media type; an example is shown in Figure 5.

**Figure 5.** Example Workflow for Testing Multiple Types of Media.

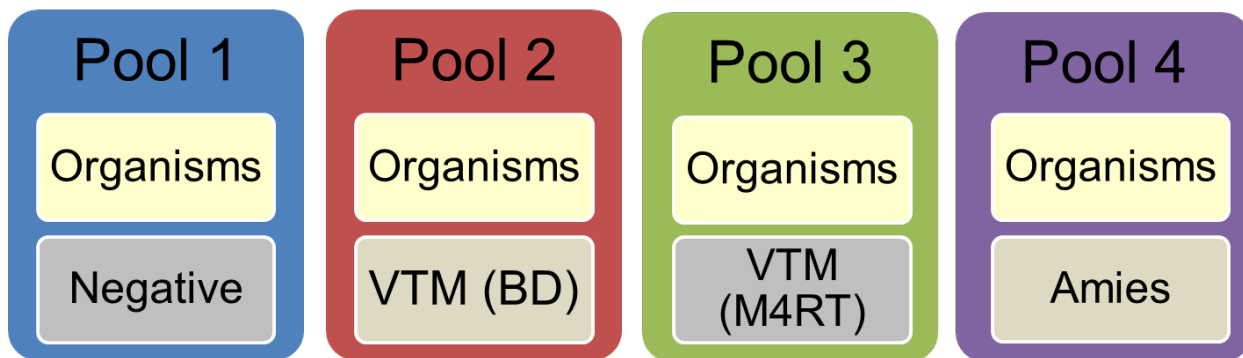

- 2) To perform a more extensive verification study, the volumes listed in Table 4, 5 and 6 can be increased proportionally. Using Pool 1 as an example, 0.5 mL of each organism can be combined and added to 3 mL of transport media/negative. Alternatively, additional organism pools may be prepared using the control material (NATRST-BIO) and following Steps 1-6 in the protocols above.

**Note:** Expanding the pool volume may require larger sample tubes to accommodate the increased volume.

## Verification of Loaner, Repaired, Refurbished and Permanent Replacement Modules

If it becomes necessary to verify the performance of a loaner, repaired, refurbished, or permanent replacement module, the following protocol may serve as a guideline but should be verified by the Laboratory Director.

1. Select an appropriate number of specimens and/or proficiency samples (any combination of positives and negatives) previously tested on the SPOTFIRE Respiratory/Sore Throat Panel. The Laboratory Director should determine the appropriate number of samples to test. Proficiency samples should not be pooled or diluted.
2. Select a set of controls that verify detection of all targets on the SPOTFIRE R/ST Panel.
3. Test the selected samples on the loaner, repaired, or permanent replacement module and document the results.



## Technical Support Contact Information

---

bioMérieux is dedicated to providing the best customer support available. If you have any questions or concerns about this process, please contact the BIOFIRE Technical Support team for assistance.

BIOFIRE Technical Support  
Email: [biofiresupport@biomerieux.com](mailto:biofiresupport@biomerieux.com)  
Phone: +1-801-736-6354, select Option 5

\*All product names, trademarks and registered trademarks are property of their respective owners.





## SPOTFIRE R/ST Panel: Respiratory Menu Verification Record

### BIOFIRE® SPOTFIRE® Respiratory/Sore Throat (R/ST) Panel Verification Record- Respiratory

SPOTFIRE R/ST Kit Part # \_\_\_\_\_ Module Serial # \_\_\_\_\_ Module Serial # \_\_\_\_\_  
 SPOTFIRE R/ST Kit Lot # \_\_\_\_\_ Module Serial # \_\_\_\_\_ Module Serial # \_\_\_\_\_  
 Media Type \_\_\_\_\_ Media Lot # \_\_\_\_\_

Organism and Representative Strain	Replicate Testing- Record Organism Detections																Respiratory Summary						
	1-A	1-B	1-C	1-D	2-A	2-B	2-C	2-D	3-A	3-B	3-C	3-D	4-A	4-B	4-C	4-D	# Positives	# Negatives	# Operators	# Days	# Modules	Patient Samples?	
Pool 1	Adenovirus	Type 3																					
	Coronavirus SARS-CoV-2																						
	Influenza A virus A/H1-2009																						
	Influenza B virus																						
	Parainfluenza virus	PIV4																					
	Human rhinovirus/enterovirus	Rhinovirus 1A																					
Pool 2	Adenovirus	Type 1																					
	Coronavirus (seasonal)	229E																					
		HKU1																					
	Human metapneumovirus																						
	Influenza A virus A/H3																						
	Parainfluenza virus	PIV 1																					
PIV2																							
Pool 3	Adenovirus	Type 31																					
	Coronavirus (seasonal)	NL63																					
		OC43																					
	Influenza A virus (no subtype identified)																						
	Parainfluenza virus	PIV 3																					
	Respiratory syncytial virus																						
Pool 4	<i>Bordetella parapertussis</i>																						
	<i>Bordetella pertussis</i>																						
	<i>Chlamydia pneumoniae</i>																						
	<i>Mycoplasma pneumoniae</i>																						

Reviewed by: \_\_\_\_\_  
 Signature \_\_\_\_\_ Date \_\_\_\_\_





## SPOTFIRE R/ST Panel: Sore Throat Menu Verification Record

### BIOFIRE® SPOTFIRE® Respiratory/Sore Throat (R/ST) Panel Verification Record- Sore Throat

**SPOTFIRE R/ST Kit Part #** \_\_\_\_\_ **Module Serial #** \_\_\_\_\_ **Module Serial #** \_\_\_\_\_  
**SPOTFIRE R/ST Kit Lot #** \_\_\_\_\_ **Module Serial #** \_\_\_\_\_ **Module Serial #** \_\_\_\_\_  
**Media Type** \_\_\_\_\_ **Media Lot #** \_\_\_\_\_

Organism and Representative Strain	Replicate Testing- Record Organism Detections																Sore Throat Summary								
	1-A	1-B	1-C	1-D	2-A	2-B	2-C	2-D	3-A	3-B	3-C	3-D	4-A	4-B	4-C	4-D	# Positives	# Negatives	# Operators	# Days	# Modules	Patient Samples?			
<b>Pool 1</b> Adenovirus Type 3 Influenza A virus A/H1-2009 Influenza B virus Parainfluenza virus PIV4 Human rhinovirus/enterovirus 1A																									
	<b>Pool 2</b> Adenovirus Type 1 Coronavirus (seasonal) 229E HKU1 Human metapneumovirus Influenza A virus A/H3 Parainfluenza virus PIV 1 PIV2																								
		<b>Pool 3</b> Adenovirus Type 31 Coronavirus (seasonal) NL63 OC43 Influenza A virus (no subtype Identified) Parainfluenza virus PIV 3 Respiratory syncytial virus																							
			<b>Pool 4</b> <i>Chlamydia pneumoniae</i> <i>Mycoplasma pneumoniae</i> <i>Streptococcus dysgalactiae</i> (Group C/G Strep) <i>Streptococcus pyogenes</i> (Group A Strep)																						

Reviewed by: \_\_\_\_\_  
 Signature \_\_\_\_\_ Date \_\_\_\_\_







## SPOTFIRE R/ST Panel: Combined Respiratory/Sore Throat Menu Verification Record- Sore Throat Menu Detections

BIOFIRE® SPOTFIRE® Respiratory/Sore Throat (R/ST) Panel Verification Record-Combined Respiratory and Sore Throat- Sore Throat Detections

SPOTFIRE R/ST Kit Part # \_\_\_\_\_ Module Serial # \_\_\_\_\_ Module Serial # \_\_\_\_\_  
 SPOTFIRE R/ST Kit Lot # \_\_\_\_\_ Module Serial # \_\_\_\_\_ Module Serial # \_\_\_\_\_  
 Media Type \_\_\_\_\_ Media Lot # \_\_\_\_\_

Organism and Representative Strain		Replicate Testing- Record Organism Detections																Sore Throat Summary					
		Sore Throat																# Positives	# Negatives	# Operators	# Days	# Modules	Patient Samples ?
		1-E	1-F	1-G	1-H	2-E	2-F	2-G	2-H	3-E	3-F	3-G	3-H	4-E	4-F	4-G	4-H						
Pool 1	Adenovirus Type 3																						
	Coronavirus SARS-CoV-2	N/A	N/A	N/A	N/A	N/A	N/A	N/A	N/A	N/A	N/A	N/A	N/A	N/A	N/A	N/A	N/A	N/A	N/A	N/A	N/A	N/A	N/A
	Influenza A virus A/H1-2009																						
	Influenza B virus																						
	Parainfluenza virus PIV4																						
Human rhinovirus/enterovirus Rhinovirus 1A																							
Pool 2	Adenovirus Type 1																						
	Coronavirus (seasonal)	229E																					
		HKU1																					
	Human metapneumovirus																						
	Influenza A virus A/H3																						
	Parainfluenza virus	PIV 1																					
PIV2																							
Pool 3	Adenovirus Type 31																						
	Coronavirus (seasonal)	NL63																					
		OC43																					
	Influenza A virus (no subtype Identified)																						
	Parainfluenza virus PIV 3																						
	Respiratory syncytial virus																						
Pool 4	<i>Bordetella parapertussis</i> (Respiratory)	N/A	N/A	N/A	N/A	N/A	N/A	N/A	N/A	N/A	N/A	N/A	N/A	N/A	N/A	N/A	N/A	N/A	N/A	N/A	N/A	N/A	
	<i>Bordetella pertussis</i> (Respiratory)	N/A	N/A	N/A	N/A	N/A	N/A	N/A	N/A	N/A	N/A	N/A	N/A	N/A	N/A	N/A	N/A	N/A	N/A	N/A	N/A	N/A	
	<i>Chlamydia pneumoniae</i> (Respiratory and Sore Throat)																						
	<i>Mycoplasma pneumoniae</i> (Respiratory and Sore Throat)																						
	<i>Streptococcus dysgalactiae</i> (Group C/G Strep) (Sore Throat)																						
	<i>Streptococcus pyogenes</i> (Group A Strep) (Sore Throat)																						

Reviewed by: \_\_\_\_\_  
 Signature Date

